

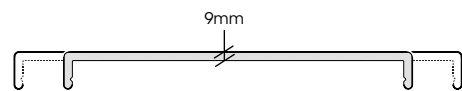









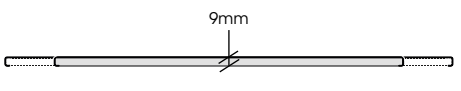
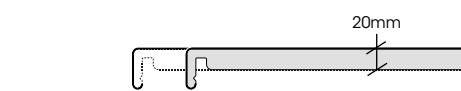
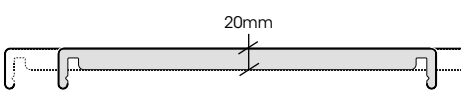

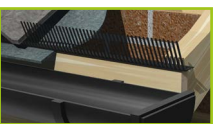

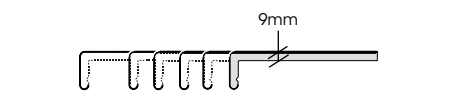
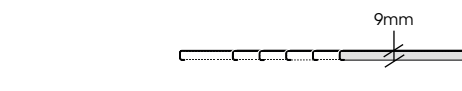
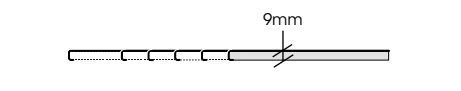
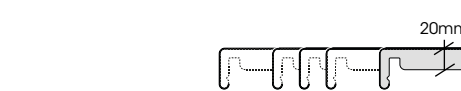
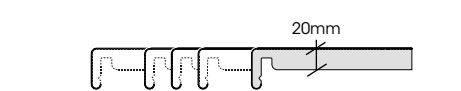





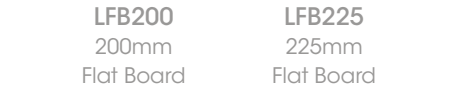







## Soffits and Fascias

 <p><b>LCB454</b> 454mm Capping Fascia Board</p>	 <p><b>LCB354</b> 354mm Capping Fascia Board</p>	 <p><b>LFB454</b> 454mm Flat Board</p>	 <p><b>LFB354</b> 354mm Flat Board</p>	 <p><b>LRB354</b> 454mm Replacement Fascia Board</p>	 <p><b>LRB354</b> 354mm Replacement Fascia Board</p>	 <p><b>G1200N</b> Over Fascia Ventilators</p>	 <p><b>G1275-01</b> Eaves Comb Filters</p>	 <p><b>G1281BL</b> Felt Tray</p>	
 <p><b>LCB150</b> 150mm Capping Fascia Board</p>	 <p><b>LCB175</b> 175mm Capping Fascia Board</p>	 <p><b>LFB150</b> 150mm Flat Board</p>	 <p><b>LFB175</b> 175mm Flat Board</p>	 <p><b>LRB150</b> 150mm Replacement Fascia Board</p>	 <p><b>LRB175</b> 175mm Replacement Fascia Board</p>	 <p><b>GDRR</b> Roll Out Dry Ridge (6m)</p>	 <p><b>G700</b> Circular Soffit Vent</p>	 <p><b>GDV-EC</b> Eaves Closer Unit</p>	
 <p><b>LCB200</b> 200mm Capping Fascia Board</p>	 <p><b>LCB225</b> 225mm Capping Fascia Board</p>	 <p><b>LFB200</b> 200mm Flat Board</p>	 <p><b>LFB225</b> 225mm Flat Board</p>	 <p><b>LRB200</b> 200mm Replacement Fascia Board</p>	 <p><b>LRB225</b> 225mm Replacement Fascia Board</p>	 <p><b>GDV-LH</b> Dry Verge (Left Hand)</p>	 <p><b>GDV-END-A</b> Angled Ridge Cap</p>	 <p><b>GDV-END-R</b> Round Ridge Cap</p>	
 <p><b>LCB250</b> 250mm Capping Fascia Board</p>	 <p><b>LCB300</b> 300mm Capping Fascia Board</p>	 <p><b>LFB250</b> 250mm Flat Board</p>	 <p><b>LFB300</b> 300mm Flat Board</p>	 <p><b>LRB250</b> 250mm Replacement Fascia Board</p>	 <p><b>LRB300</b> 300mm Replacement Fascia Board</p>	<p><b>GDV-RH</b> Dry Verge (Right Hand)</p>	<p><b>PP30</b> 30mm Fixing Pin</p>	<p><b>PP40</b> 40mm Fixing Pin</p>	<p><b>PN65</b> 65mm Fixing Nail</p>
 <p><b>LSB100</b> 100mm Soffit Board</p>		 <p><b>LSB300</b> 300mm Soffit Board</p>							

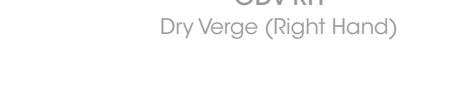
## Trims

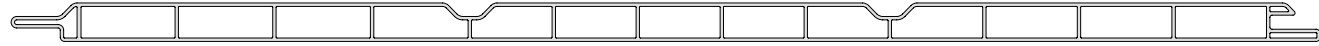
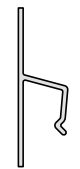
 <p><b>LFRT9</b> Felt Roof Trim</p>	 <p><b>LSV10</b> Soffit Ventilator</p>	 <p><b>LHJT9</b> 'H' Joint Trim</p>
 <p><b>LFWT9</b> 'F' Wall Trim</p>	 <p><b>LJST9</b> 'J' Starter Trim</p>	 <p><b>L2PT9</b> 2 Part Trim</p>

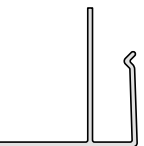
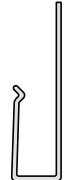
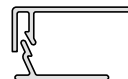
## Mouldings

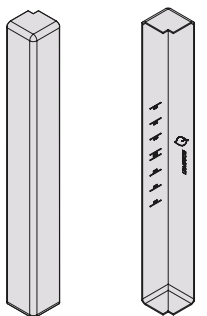
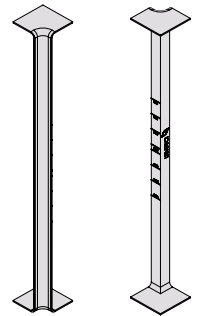
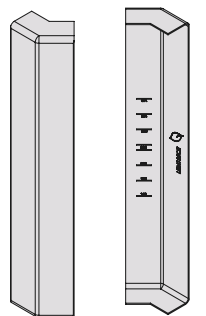
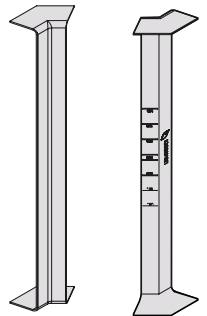
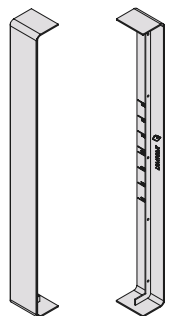
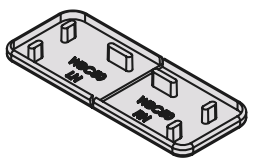
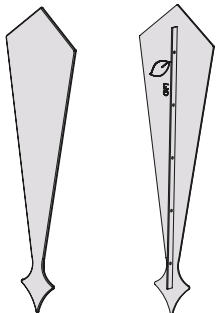
 <p><b>LRM90CE</b> 90 Deg Corner External</p>	 <p><b>LRM90CI</b> 90 Deg Corner Internal</p>	 <p><b>LRM135CE</b> 135 Deg Corner External</p>	 <p><b>LRM135CI</b> 135 Deg Corner Internal</p>	 <p><b>LRM180JT</b> In-Line Joint Trim</p>	 <p><b>WBC50</b> Window Board End Cap</p>	 <p><b>GF1</b> Gable Finial</p>
--	--	--	--	---	--	--